

BEAM DIAGRAMS AND COMMON FORMULAS

Simply Supported Beams

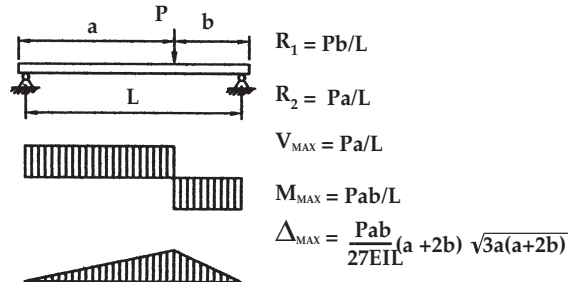

Fixed End Beams

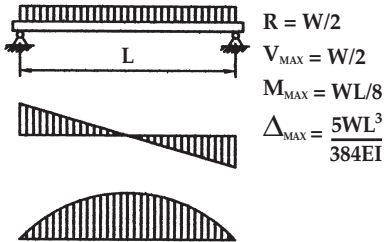
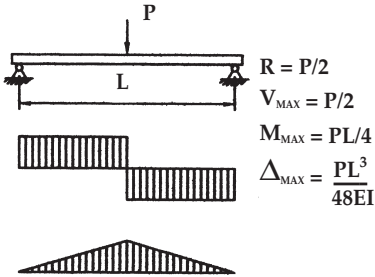
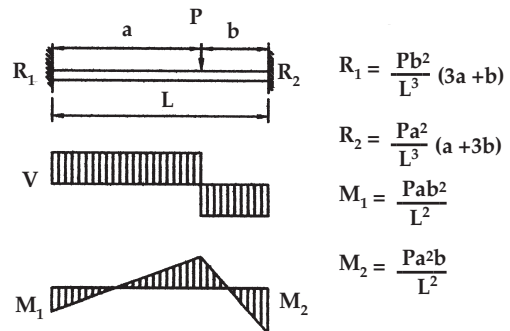
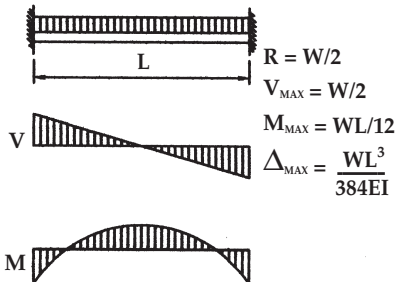
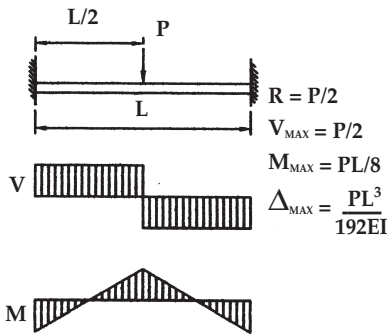

Cantilever Beams

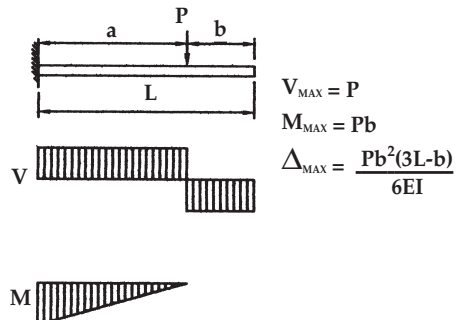
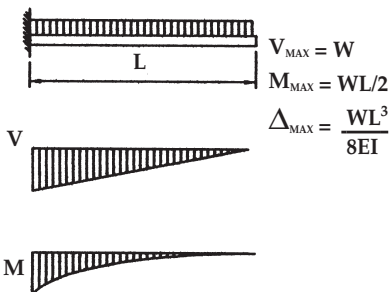
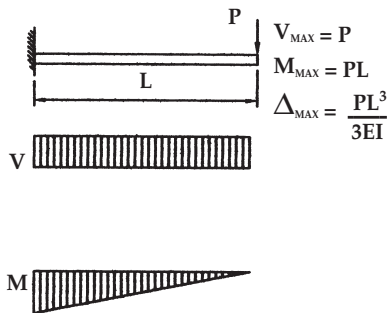

Beams with one end Fixed, one end Simply Supported

